

Contract No. 13/WSD/17 First Stage of Tseung Kwan O Desalination Plant

SILT CURTAIN DEPLOYMENT PLAN

Document No.: TKOD1-PLN-A002-CMR0001-03



Submitted to: Water Supplies Department
Submitted by: AJC Joint Venture
Date: 12 OCT 2020



Water Supplies Department
New Works Branch
Consultants Management Division
6/F Sha Tin Government Offices
1 Sheung Wo Che Road
Sha Tin
New Territories

Your reference:

Our reference: HKWSD202/50/106850

Date: 20 October 2020

Attention: Mr W K Lau

BY EMAIL & POST
(email: simon_wk_lau@wsd.gov.hk)

Dear Sirs

Agreement No. CE 5/2019 (EP)
Independent Environmental Checker for First Stage of
Tseung Kwan O Desalination Plant– Investigation
Verified Silt Curtain Deployment Plan

We refer to emails of 16 and 20 October 2020 attaching a finalized Silt Curtain Deployment Plan for the captioned project prepared by the AJC Joint Venture.

We have no further comment and hereby verify the finalized Silt Curtain Deployment Plan in accordance with Clause 2.10 of the Environmental Permit no. EP-503/2015/A and the Further Environmental Permit no. FEP-01/503/2015/A.

Should you have any queries regarding the above, please do not hesitate to contact the undersigned or our Miss Reasonlie Cheung on 2618 2831.

Yours faithfully
ANEWR CONSULTING LIMITED

Adi Lee
Independent Environmental Checker

LYMA/CYYR/lsm



Our Ref. : L2020102001
Date : 20th October 2020

By Email

AJC Joint Venture
5/F, Tower A, Manulife Financial Centre,
223-231 Wai Yip Street,
Kwun Tong, Kowloon, Hong Kong
Attn: Mr. Brian Kam (Environmental Monitoring Manager)

Dear Mr. Kam,

Contract No. 13/WSD/17
Design, Build and Operate First Stage of Tseung Kwan O Desalination Plant
Silt Curtain Deployment Plan

I refer to the revised Silt Curtain Deployment Plan issued on 12th October 2020 and finalized on 20th October 2020. Please note that we herewith certify the captioned submission in accordance with Condition 2.10 of Environmental Permit EP-503/2015/A and Further Environmental Permit FEP-01/503/2015/A.

Should you have any queries, please do not hesitate to contact the undersigned at 2698 6833.

Yours faithfully,

For and on behalf of
Acuity Sustainability Consulting Limited

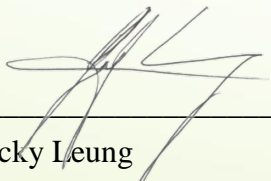

Jacky Leung
Environmental Team Leader

Table of Content

1.0 Introduction.....	1
1.1 Background	
1.2 Purpose and Scope of the Deployment Plan	
2.0 Construction Programme of Marine-based Works.....	2
3.0 Silt Curtain Designs	3
3.1 Floating Type Silt Curtain	
3.2 Cage (Framed) Type Silt Curtain	
4.0 Silt Curtain Installation for Marine-based Works	4
5.0 Silt Curtain Efficiency Test Plan	7
5.1 Monitoring Locations	
5.2 Monitoring Parameters	
5.3 Monitoring Equipment	
5.4 Sampling/ Testing Protocols	
5.5 Laboratory Measurement and Analysis	
5.6 Sampling Depth and Replication	
5.7 Monitoring Frequency and Arrangements	
5.8 Evaluation of Loss Reduction Factor	
5.9 Reporting of Evaluation Results	
6.0 Silt Curtain Operation & Maintenance	12
7.0 Silt Curtain Removal/ Repositioning	12
8.0 Implementation Schedule of the SCDP	13

APPENDICES

Appendix A – Extracted Implementation Schedule of Water Quality Mitigation Measures in the EM&A Manual	
Appendix B – Tentative Programme for Marine-based Works	
Appendix C – Specifications of Geotextile for Silt Curtain	
Appendix D – Typical Sections of Proposed Floating Type Silt Curtain	
Appendix E – Typical Sections of Proposed Cage (Framed) Type Silt Curtain	
Appendix F – Layout of Deployment of Combined Use of Floating Type and Cage (Framed) Type Silt Curtains at Receiving Pit of Seawater Intake	
Appendix G – Layout of Deployment of Floating Type Silt Curtain Deployment at Receiving Pit of Marine Outfall	
Appendix H – Layout of Deployment of Double Layer Silt Curtain at Submarine Outfall Diffuser	
Appendix I – Silt Curtain Inspection Checklist	
Appendix J – Project-specific Implementation Schedule of the SCDP	

1. Introduction

1.1 Background

In exploring new water resources as part of the Total Water Management strategy, Water Supplies Department of HKSAR (WSD) has proposed a desalination plant adopting the Seawater Reverse Osmosis (SWRO) technology to supplement the water supply in meeting the Hong Kong's water demand. WSD being the Project Proponent has conducted an environmental impact assessment (EIA) study for the Tseung Kwan O Desalination Plant (TKODP) that the respective EIA Report (AEIAR-192/2015) was approved under the EIA Ordinance on 4 November 2015. Subsequently the first Environmental Permit (EP) No. EP-503/2015 was issued on 4 December 2015 and the later variation of EP (No. EP-503/2015/A) issued on 26 January 2018.

In late 2019, WSD commissioned Acconia Agua SA - Jardine Engineering Corporation Limited – China State Construction Engineering (HK) Limited Joint Venture (AJCJV) to design, construct and operate a SWRO desalination plant at Tseung Kwan O Area 137 under the Contract No. 13/WSD/17 – *Design, Build and Operate First Stage of Tseung Kwan O Desalination Plant*. Upon award of the Contract, AJCJV applied a Further EP (No. FEP-01/503/2015/A) which was issued on 20 December 2019. Pursuant to a FEP condition, a silt curtain deployment plan shall be prepared and properly implemented.

1.2 Purpose and Scope of the Deployment Plan

In the EIA study, potential water quality impact was anticipated during the dredging operation for the construction of submarine outfall and seawater intake structures. Therefore the *“mitigation measure in form of (1) floating type silt curtain around grab dredger would be adopted for dredging at the proposed submarine outfall and (2) combine used of one floating type silt curtain and one cage type silt curtain for dredging at seawater intake”*. Section 6.9.1 of the EIA Report refers.

Per the EIA recommendations, the guiding Environmental Mitigation Implementation Schedule (EMIS) was proposed in the Environmental Monitoring & Auditing (EM&A) Manual that the water quality mitigation measures, including the deployment of silt curtains, regular silt curtain inspections and silt curtain efficiency testing should be implemented during the construction stage. The excerpt of EMIS table was given in Appendix A.

Also, Condition 2.10 of the FEP specifies that *“No later than 3 months before the commencement of marine works involving deployment of silt curtains of the Project, 3 hard copies and 1 electronic copy of the Silt Curtain Deployment Plan shall be submitted to the Director for record. The Plan shall include the construction programme and details on the design, operation and maintenance of silt curtains(s) to be deployed during the construction”*.

This Silt Curtain Deployment Plan (SCDP) takes account of the mitigation measure of the EIA study and has been prepared in accordance with the FEP condition with the following details.

- Construction Programme for the Marine Work;
- Silt Curtain Designs
- Silt Curtain Installation for Marine-based Works
- Silt Curtain Efficiency Test Plan
- Silt Curtain Operation & Maintenance

2. Construction Programme of Marine-based Works

The marine-based works involved for the construction of permanent marine structures (i.e. seawater intake, outfall diffuser and associated submarine pipelines) comprise the followings.

- Marine site investigation
- Pipe jacking (mini-TBM) for submarine pipelines construction
- Temporary receiving pits construction at intake and outfall locations
- Outfall diffuser installation

Figure 1.1 below indicates the locations of the marine structures and respective work areas.

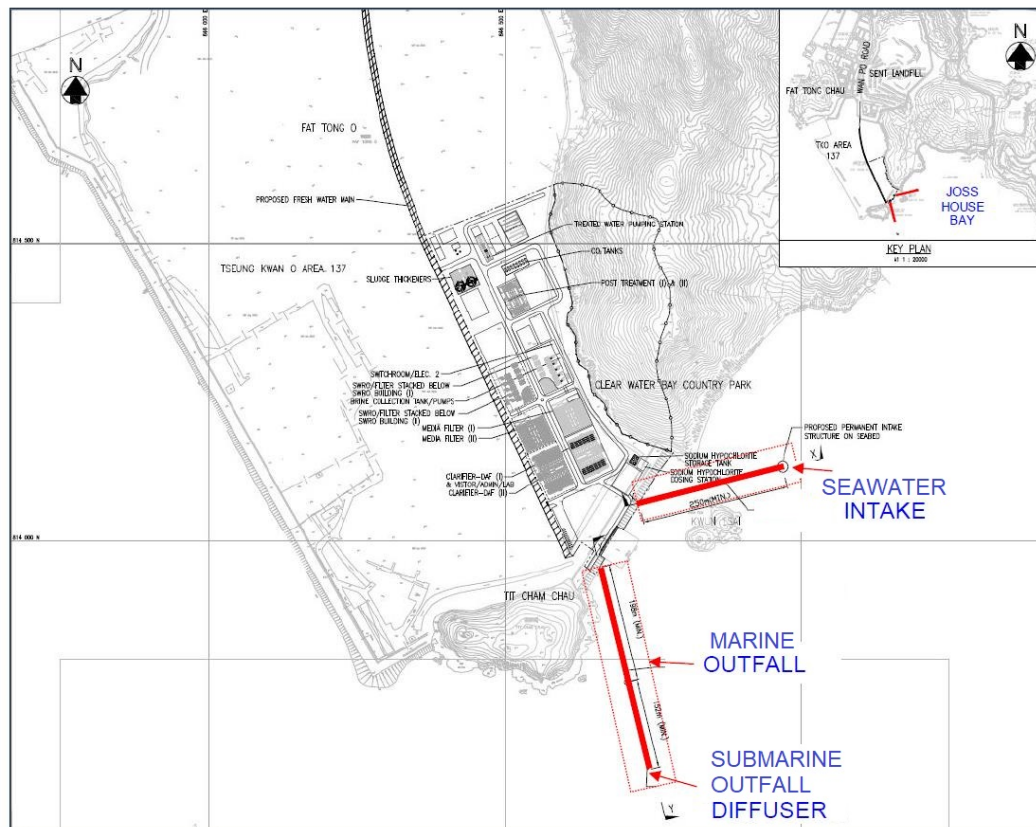

Figure 1.1 - Location Plan of the marine structures

While the marine site investigation as a site preparation work would be carried out in early stage, the major marine-based work would commence as early as in November/ December 2020. AJCJV has programmed the works with full observance of the precautionary measures that the dredging work for the seawater intake and outfall diffuser shall not be carried out concurrently and the dredging rate limitations (i.e. $\leq 750\text{m}^3$ per day & $\leq 62\text{m}^3$ per hour and $\leq 3,500\text{m}^3$ per day & $\leq 291\text{m}^3$ per hour for intake and outfall structures respectively as per the FEP Condition 2.14 and 2.15. The closed grab dredger shall be deployed primarily. The use of other type of dredging method may be possible unless otherwise approved by EPD. A brief programme showing the tentative commencement and completion dates of the marine-based works is given in Appendix B.

3. Silt Curtain Designs

3.1 Floating Type Silt Curtain

Floating type silt curtain consists of single layer of continuous geotextile sheeting (its specifications with respective product catalogue proposed in Appendix C) tied on 300mm diameter buoys (floaters) and being hanged to the seabed level holding in vertical position by steel chain ballast. The buoys (floaters) would be tied down by slant steel wires at regular intervals onto concrete sinkers (approx. 3 tonnes each) with maximum 15m centre-to-centre distance apart for anchorage to avoid the silt curtain system from drifting off by wave action. For area with faster current velocity closer spacing would be adopted as necessary to stabilize the silt curtain. The terminals of the buoys (floaters) would be further attached by nylon ropes onto the hull of working vessel. Sufficient length of geotextile shall be allowed such that the silt curtain can be extended from the water surface to the seabed during high tide condition. The curtain depth shall be of minimum which is the water depth at low tide plus 2m tidal range. Down along the seam/ stitching of the geotextile, there sits with a winching rope to adjust the curtain depth whenever necessary such that the geotextile sheeting would not billow excessively due to the change of tidal levels. Along the bottom shirt of geotextile sheeting there would be weighted by steel chain ballast (generally 8mm chain of weight 1.45 kg/m) to hold the curtain in a vertical position. For maritime safety, the 4 corners of the silt curtain floaters and anchor buoys (i.e. floating objects) shall be installed with yellow flashing lights in strict accordance with the prevailing Marine Department Notice (MDN). The typical sections of the proposed floating type silt curtain are depicted in Appendix D.

3.2 Cage (Framed) Type Silt Curtain

Cage (Framed) type silt curtain consists of single layer of geotextile sheeting (i.e. same material of Floating type silt curtain) mounted on a fixed metal fixture (e.g. staging platform) or a metal frame attaching to the working vessel, viz. Design A and B respectively, not freely drifted by wave actions that the geotextile sheeting forms a closed-loop to completely enclose the spot of dredging work. Sufficient length of geotextile shall be allowed such that the silt curtain can be extended from the water surface to the seabed during high tide condition. The curtain depth shall be of minimum

which is the water depth at low tide plus 2m tidal range. Down along the seam/ stitching of the geotextile, there sits with a winching rope to adjust the curtain depth whenever necessary such that the geotextile sheeting would not billow excessively due to the change of tidal levels. Along the bottom shirt of geotextile sheeting there would be weighted by steel chain ballast (generally 8mm chain of weight 1.45 kg/m) to hold the curtain in a vertical position. Typical sections of the proposed cage (framed) type silt curtain are given in Appendix E.

4. Silt Curtain Installation for Marine-based Works

Given the various marine-based activities, different types or a combination of silt curtains would be proposed.

Marine Site Investigation – The work does not involve any dredging of the existing marine sediment and is of temporal basis, no installation of silt curtains would be suggested during the work.

Pipe Jacking by mini-TBM – The work starts at the land-based combined shaft, proceeding horizontally below the seabed before reaching the proposed receiving pits at intake and outfall respectively. Pipe jacking is a kind of trenchless method involving neither any dredging work nor interfacing with the open water body. No installation of silt curtains should be considered necessary.

Receiving Pit at Seawater Intake – It would be a rectangular receiving pit of dimension approximately 10m x 10m formed by socket-H pipe pile cofferdam walls at 4 sides.

- 1) *Installation and Removal of Temporary Working Platform* – To accommodate the necessary plant for construction of cofferdam as for the receiving pit, a temporary steelwork of staging platform prefabricated with suction piles (approximately 3.5m diameter and 10m long each) at 4 corners would be placed on the seabed. Anchoring the staging platform – suction pile assembly would be accomplished with its self-weight and by vacuum action from pumping out the air/ water inside the pile. Reference is made to the Wind Farm EIA (https://www.epd.gov.hk/eia/register/report/eiareport/eia_1672009/index_pdf.html) revealing that the water being pumped out from the suction caisson (pile) could be directly discharged to the surrounding water without significantly impacting the water quality. Being a prudent measure, the suction water during the platform installation would be discharged within the working zone enclosed by single layer of silt curtain (Design A arrangement as in Appendix E), in any event the pumping volume & rate would be checked by pumps with limited capacity. The staging platform removal at later stage would be a reverse process that the low pressure inside the suction pile be relieved to ease the final lifting off the platform whereby the seabed sediment would not be significantly disturbed and no sediment would be dredged/ excavated.

- 2) *Construction and Removal of Cofferdam* – The rectangular cofferdam structure would be formed by contiguous pipe piles which are to be constructed by the piling machine sitting on the staging platform with the silt curtain per Design A arrangement as in Appendix E. On completion of the seawater intake, the pipe piles would be either flame-cut at seabed level by divers or mechanically retrieved off the seabed whereupon the silt curtain as per Design A of Appendix E would be in place.
- 3) *Formation of Receiving Pit* – Upon completing the cofferdam for receiving pit, dredging work would be carried out inside the cofferdam by a closed grab dredger or a closed grab on a derrick barge. In fact, the cofferdam of which the top level shall be well above sea level at all tidal conditions, can serve as an effective shield to contain any sediment loss from the receiving pit. Conforming the respective EP requirement, the combined use of Cage (Framed) Type and Floating Type Silt Curtains should be deployed during the course of dredging where the inner Cage (Framed) Type Silt Curtains be fixed along the perimeter of the working platform and the outer Floating Type Silt Curtain enclosing the whole dredging zone and staging platform. The layout of silt curtain deployment arrangement is shown in Appendix F.

Receiving Pit at Marine Outfall – It would be a circular shape receiving pit formed by a prefabricated cylindrical steel cofferdam.

- 1) *Installation and Removal of Cofferdam* – As per the marine site investigation data, the local bedrock sits right on the seabed level of the receiving pit location. The receiving pit would be formed by sinking a prefabricated steel caisson (e.g. cylindrical metal casing), followed by installation of Floating Type Silt Curtain as in Appendix G. The silt curtain would be maintained in place during the course of cofferdam construction. On completion of the outfall, steel caisson or metal casing would be flame-cut by divers at seabed level and be removed off the site.
- 2) *Formation of Receiving Pit* – Inside the cylindrical cofferdam, the underneath bedrock would be trimmed and leveled by chiseling. With the rock fragment cleared by grabbing, the base of cofferdam would be finally grout plugged. During the course of work as described above, Floating Type Silt Curtain should be deployed. The layout of silt curtain deployment arrangement is shown in Appendix G. The deployment of Floating Type Silt Curtain would be maintained during the further bedrock breaking work until reaching the formation level inside the cofferdam.

Submarine Outfall Diffuser – Submarine outfall diffuser shall be constructed by prefabricated structures sitting on seabed formation level which would be accomplished by dredging along the diffuser footprint. Dredging of sediment would be carried out section by section where the Cage (Framed) Type Silt Curtain (Design B of Appendix E) with an additional layer of silt curtain sheeting would be deployed during the course of dredging and during the later stage of rock filling work to complete the diffuser. The layout of silt curtain deployment arrangement is shown in Appendix H.

The general silt curtain assembling procedures are described below.

1. Prepare the geotextile with size suitable for the specific platform size on the derrick lighter/ barge.
2. Tie the top end of the geotextile and connected to the reinforced belt, the bottom end with the steel chain ballast.
3. Row up the bottom part of the silt curtain to the specific length to enable it being lifted up by the derrick lighter/ barge.
4. Lift the silt curtain assembly up and place it above the deployment zone, e.g. staging platform, cofferdam, framed floater, etc. without the bottom part of the silt curtain tangled in other anchor wiring and buoys in vicinity.
5. Lower the silt curtain with steel chain ballast in position into the sea.
6. Workers with life jackets then tie the silt curtain assembly onto staging platform/ hull of the working vessel or the anchor sinkers by steel/ nylon rope for stabilization.

5. Silt Curtain Efficiency Test Plan

Reference is made to EMIS and Annex C of the EM&A Manual that a pilot test for silt removal efficiency of the combined use of single layer of floating type silt curtain and a cage type silt curtain would be conducted for the dredging work at the seawater intake receiving pit only. Given short period of dredging for inconsiderable dredging volume is anticipated, a small-scale efficiency test would be proposed on the first two days of dredging.

5.1 Monitoring Locations

The monitoring locations would be determined based upon the locations of dredging activities and safe distance from the working grab or plant. Three (3) sets of monitoring stations would be arranged, comprising both Impact zone and Outer zone of the silt curtain as well as upstream control stations for impact water quality monitoring. The locations of the sampling station are described in Table 5.1 and depicted in Figure 5.1.

Station ID	Description	Coordinates*
In	Impact zone – area enclosed by both layers of silt curtains	E: 846960 N: 814130
Oe	Outer zone – downstream location of ebb tide at approximately 100m from the dredging area	E: 847030 N: 814200
Of	Outer zone – downstream location of flood tide at approximately 100m from the dredging area	E: 846890 N: 814060
Ce	Upstream control station during ebb tide	E: 845800 N: 814110
Cf	Upstream control station during flood tide	E: 848910 N: 813340

* Subject to adjustment according to site activities and situations

Table 5.1 – Monitoring Stations for the Silt Curtain Efficiency Testing

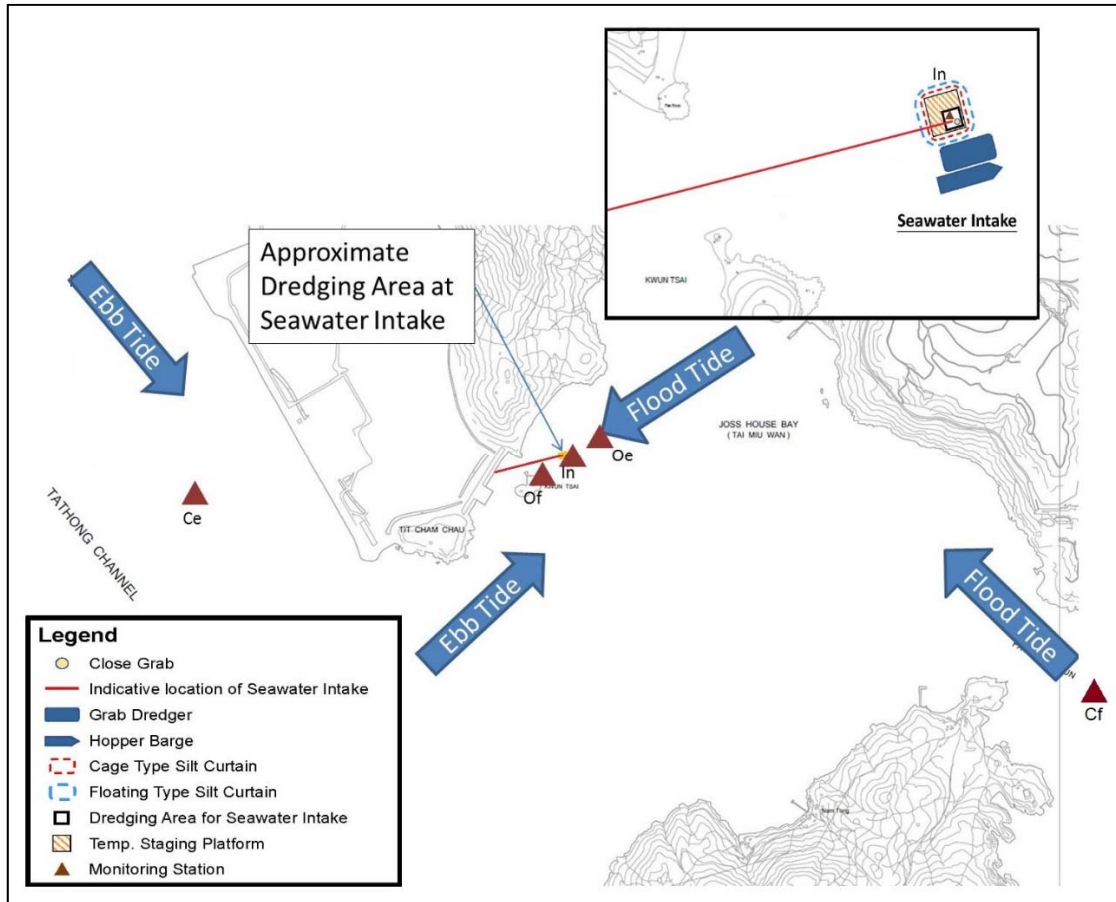

Figure 5.1 – Monitoring Stations of Silt Curtain Efficiency Testing

5.2 Monitoring Parameters

The parameters selected for measurement *in situ* and in the laboratory are those recommended in the EIA Report that could be affected by the dredging at seawater intake and other general water quality parameters. Suspended solid would be measured in the laboratory for silt curtain efficiency evaluation. The water quality parameters to be measured are tabulated in Table 5.2.

Water Quality Parameter	Measurement Type
Suspended Solids	Laboratory analysis
Turbidity	<i>In-situ</i>
Dissolved Oxygen	<i>In-situ</i>
Salinity	<i>In-situ</i>
Temperature	<i>In-situ</i>

Table 5.2 – Water Quality Parameters to be Measured

In addition to the water quality parameters, other relevant data, including the locations of sampling locations, water depth, time, weather conditions, sea conditions, tidal stage, current direction and velocity would also be measured and logged. Specific observations and work activities undertaken around the monitoring and works area that may influence the monitoring results should be recorded.

5.3 Monitoring Equipment

- ***Dissolved Oxygen and Temperature Measuring Equipment*** - The instrument will be a portable, weatherproof dissolved oxygen measuring instrument complete with cable, sensor, comprehensive operation manuals, and will be operable from a DC power source. It will be capable of measuring: dissolved oxygen levels in the range of 0 - 20 mg/L and 0 - 200% saturation; and a temperature of 0 - 45 degrees Celsius. It shall have a membrane electrode with automatic temperature compensation complete with a cable of not less than 35 m in length. Sufficient stocks of spare electrodes and cables shall be available for replacement where necessary (e.g. YSI model 59 DO meter, YSI 5739 probe, YSI 5795A submersible stirrer with reel and cable or an approved similar instrument).
- ***Turbidity Measurement Equipment*** - The instrument will be a portable, weatherproof turbidity-measuring unit complete with cable, sensor and comprehensive operation manuals. The equipment will be operated from a DC power source, it will have a photoelectric sensor capable of measuring turbidity between 0 - 1000 NTU and will be complete with a cable with at least 35 m in length (for example Hach 2100P or an approved similar instrument).
- ***Salinity Measurement Instrument*** - A portable salinometer capable of measuring salinity in the range of 0 - 40 ppt will be provided for measuring salinity of the water at each monitoring location.
- ***Water Depth Gauge*** – A portable, battery-operated echo sounder (for example Seafarer 700 or a similar approved instrument) will be used for the determination of water depth at each designated monitoring station. This unit will preferably be affixed to the bottom of the work boat if the same vessel is to be used throughout the monitoring period.
- ***Current Velocity and Direction*** – A current meter capable of measuring the velocity and direction of flow in the range of 0 – 6 m/s (± 0.01 m/s) and 0° to 360° ($\pm 2^\circ$), respectively, will be used (e.g. Falmouth Scientific, Inc. 2-Dimensional Acoustic Current Meter or a similar approved instrument).
- ***Positioning Device*** – A Differential Global Positioning System (DGPS) shall be used during monitoring to allow accurate recording of the position of the monitoring vessel before taking measurements. The DGPS should be suitably calibrated at appropriate checkpoint to verify that the monitoring station is at the correct position before the water quality monitoring commences.

- **Water Sampling Equipment** - A water sampler, consisting of a PVC or glass cylinder of not less than two litres, which can be effectively sealed with cups at both ends, will be used (e.g. Kahlsico Water Sampler 13SWB203 or an approved similar instrument). The water sampler will have a positive latching system to keep it open and prevent premature closure until released by a messenger when the sampler is at the selected water depth.

Prior to the Pilot Tests, the valid calibration certificates of the monitoring equipment to be used in situ will be provided to the SOR, the ET, and IEC for agreement. All valid calibration certificates will be attached to the monitoring report.

5.4 Sampling/ Testing Protocols

All *in situ* monitoring instruments will be checked, calibrated and certified by a laboratory accredited under HOKLAS or any other international accreditation scheme before use. Responses of sensors and electrodes will be checked with certified standard solutions before each use.

On-site calibration of field equipment shall follow the “*Guide to On-Site Test Methods for the Analysis of Waters*”, BS 1427: 2009. Sufficient stocks of spare parts shall be maintained for replacements when necessary. Backup monitoring equipment shall also be made available so that monitoring can proceed uninterrupted even when equipment is under maintenance, calibration etc.

5.5 Laboratory Measurement and Analysis

All laboratory work shall be carried out in a HOKLAS accredited laboratory. Water samples of about 1,000 mL shall be collected at the monitoring and control stations for carrying out the laboratory analyses. Water samples for SS measurements will be collected in high density polythene bottles, packed in ice (cooled to 4° C without being frozen), and delivered to a HOKLAS laboratory as soon as possible after collection.

The determination work shall start within the next working day after collection of the water samples. The SS laboratory measurements shall be provided to the client within 7 working days upon the receipt of the samples. The analyses shall follow the standard methods as described in APHA Standard Methods for the Examination of Water and Wastewater, 19th Edition, unless otherwise specified (APHA 2540D for SS) with a detection limit of 0.5 mg/ L.

5.6 Sampling Depths and Replication

Unless otherwise specified, each station will be sampled and measurements will be taken at three depths, 1 m below sea surface, mid-depth and 1 m above the seabed. Duplicate (2) readings of the *in situ* measurements and duplicate (2) SS samples will be made at each water depth at each station. For stations that are less than 3 m in depth and the Impact zone (In) station where the water column inside dredging zone would be readily mixed, only the mid depth sample will be taken. For stations that are less than 6 m in depth, the mid-depth station will be omitted. As the QA/QC procedures for

the in-situ measurement of DO and Turbidity, where the difference in value between the first and subsequent measurements at a certain depth is more than 25% of the value of the first measurement, the measurements should be discarded and further measurements should be taken to confirm the values.

5.7 Monitoring Frequency and Arrangements

Monitoring will be conducted at all designated stations on the day with dredging work at seawater intake. The monitoring will be conducted at an interval of two hour throughout the day. A total of 7 sampling event will be conducted. The first monitoring event should be conducted right before the dredging event to serve as a baseline condition.

Time	Monitoring	Stations	Sample Quantities	Duration
Day 1				
14:00	Baseline	In, Ce, Oe, Cf, Of	2 replicates x (3 depths 5 stations) = 30	Prior to impact monitoring when no dredging work is carried out
Day 2				
08:00	Impact	(In [#] , Ce, Oe) OR (In [#] , Cf, Of)*	2 replicates x (3 depths x 2 stations + 1 depth x 1 station) = 14	First impact sampling event
10:00	Impact	(In [#] , Ce, Oe) OR (In [#] , Cf, Of)*	2 replicates x (3 depths x 2 stations + 1 depth x 1 station) = 14	After 2 hrs from the previous sampling event
12:00	Impact	(In [#] , Ce, Oe) OR (In [#] , Cf, Of)*	2 replicates x (3 depths x 2 stations + 1 depth x 1 station) = 14	After 2 hrs from the previous sampling event
14:00	Impact	(In [#] , Ce, Oe) OR (In [#] , Cf, Of)*	2 replicates x (3 depths x 2 stations + 1 depth x 1 station) = 14	After 2 hrs from the previous sampling event
16:00	Impact	(In [#] , Ce, Oe) OR (In [#] , Cf, Of)*	2 replicates x (3 depths x 2 stations + 1 depth x 1 station) = 14	After 2 hrs from the previous sampling event
18:00	Impact	(In [#] , Ce, Oe) OR (In [#] , Cf, Of)*	2 replicates x (3 depths x 2 stations + 1 depth x 1 station) = 14	After 2 hrs from the previous sampling event

During dredging operation at the intake, the whole water column inside the impact station would be readily mixed thus one mid-depth sample would be considered representative. Safety considerations were also taken to minimize the duration of the sampling technician who would stay on the stage platform.

* Only monitoring stations at the corresponding tide would be required. For instance, only the impact station (In), control stations for ebb tide (Ce) and outer station for ebb tide (Oe) would be required for an ebb tide condition.

5.8 Evaluation of Loss Reduction Factor

The efficiency of the silt curtains will be evaluated against the relevant loss reduction factor for suspended solids, using the following equation.

$$(SS_{\text{inside}} - SS_{\text{outside}}) / SS_{\text{inside}} \times 100\%$$

5.9 Reporting of Evaluation Results

The monitoring results and respective evaluation of loss reduction factor against the EIA assumption of $\geq 95\%$ would be reported within 30 working days following the completion of the monitoring. Copies of the monitoring results of the Silt Curtain Efficiency Test will be provided to SOR, ET, IEC and EPD as appropriate for record.

6. Silt Curtain Operation & Maintenance

On-board supervisors will be assigned to check the condition of the silt curtain before commencement of works every day. An inspection checklist will be prepared and filled in by the Site Supervisors. All checklists will be kept on site for record purpose. Refer Appendix I for the sample of Silt Curtain Inspection Checklist.

Dredging or rock backfilling works will stop immediately if silt curtain is found damaged. Lift up the silt curtain by barge. A new piece of geotextile is used to repair the damage area. Nearby marine works will resume after repairing of the damaged silt curtain.

The silt curtain may be removed before the adverse weather at further stage. For the tentative arrangement of silt curtain under adverse weather, the silt curtain would be removed temporarily during adverse weather and related works would be suspended immediately until the silt curtain is installed again.

Refuse around the silt curtains will be collected at regular intervals on a daily basis so that water behind the silt curtains will be kept free from floating debris.

Sufficient spare geotextile will be kept on site for replacing of damaged silt curtains. The spare geotextile shall be kept in place to avoid direct contact with water and sunlight.

7. Silt Curtain Removal/ Repositioning

Prior to removal of silt curtains, all marine works for which the silt curtains are deployed shall be stopped and visual inspection of the water quality within the area protected by silt curtains shall be conducted to confirm no sediment plume remaining within the works area before commencing silt curtain removal.

Floating silt curtains shall be removed by detaching the chain connecting the silt curtain to the anchors. Care should be taken to protect the silt curtain skirt from damage as it is dragged from the water. The remaining anchors shall be individually connected to the crane by divers and carefully lifted off the seabed for recovery onto the barge to minimize the disturbance to the seabed.

Actions upon repositioning of silt curtain will be same as deployment of a new silt curtain. The condition of the silt curtain will be jointly inspected with the Site Supervisor before relocation to the new position.

8. Implementation Schedule of the SCDP

The implementation schedule of proposed specific measures with details of undertaking parties, location of measures, timeframe, etc. is given in Appendix J.

Appendix A

Extracted Implementation Schedule of Water Quality Mitigation Measures in the EM&A Manual

EIA Reference	Recommended Environmental Protection Measures/ Mitigation Measures	Objectives of the recommended measures & main concerns to address	Implementation Agent	Implementation Stage			Relevant Legislation & Guidelines
				D	C	O	
			Checker (IEC)				
Water Quality							
S 6.9	Silt curtains shall be deployed during dredging to reduce the elevation of suspended solids to nearby sensitive receivers. Single layer of floating type silt curtain around grab dredger shall be used for dredging at submarine outfall and combined used of floating type silt curtain and cage type silt curtain should be adopted for dredging at seawater intake.	Marine Dredging/ During construction	Contractor(s)		✓		-
S6.9	Closed grab dredger should be used to reduce the potential for leakage of sediments.	Marine Dredging/ During construction	Contractor(s)		✓		-
S6.9	Closed grab of 3 to 6 m ³ will be used for dredging at seawater intake.	Marine Dredging at intake/ During construction	Contractor(s)		✓		-
S6.9	Specific work staff will be assigned the responsibility for monitoring the number of grab dredged per hour. Number of cycle shall be limited to 20 - 21 grab per hour for 3m ³ closed grab; 10 - 11 grab per hour for 6 m ³ closed grab.	Marine Dredging / During construction	Contractor(s)		✓		-
S6.9	The grab shall be operated in slow and controlled manner such that the impact to seabed by the grab when being lowered could be minimized. Also, the operator should ensure the grab be properly closed before lifting the grab.	Marine Dredging / During construction	Contractor(s)		✓		-
S6.9	The maximum allowed dredging rate at the seawater intake should be limited to 750 m ³ /day while the maximum allowed dredging rate at the submarine outfall is 3,500 m ³ /day.	Marine Dredging/ During construction	Contractor(s)		✓		-
S6.9	Dredged marine sediment will be disposed of in a gazetted marine disposal area in accordance with	Marine Dredging/ During construction	Contractor(s)		✓		Dumping at Sea Ordinance (DASO)

EIA Reference	Recommended Environmental Protection Measures/ Mitigation Measures	Objectives of the recommended measures & main concerns to address	Implementation Agent	Implementation Stage			Relevant Legislation & Guidelines
				D	C	O	
	marine dumping permit conditions of the Dumping at Sea Ordinance (DASO).						
S6.9	Disposal vessels will be fitted with tight bottom seals in order to prevent leakage of material during transport.	Marine Dredging/ During construction	Contractor(s)		✓		-
S6.9	Barges will be filled to a level, which ensures that material does not spill over during transport to the disposal site and that adequate freeboard is maintained to ensure that the decks are not washed by wave action.	Marine Dredging/ During construction	Contractor(s)		✓		-
S6.9	After dredging, any excess materials will be cleaned from decks and exposed fittings before the vessel is moved from the dredging area.	Marine Dredging/ During construction	Contractor(s)		✓		-
S6.9	The contractor(s) will confirm that the works cause no visible foam, oil, grease, litter or other objectionable matter to be present in the water within and adjacent to the dredging site.	Marine Dredging/ During construction	Contractor(s)		✓		-
S6.9	When the dredged material has been unloaded at the disposal areas, any material that has accumulated on the deck or other exposed parts of the vessel will be removed and placed in the hold or a hopper. Under no circumstances will decks be washed clean in a way that permits material to be released overboard.	Marine Dredging/ During construction	Contractor(s)		✓		-
S6.9	Dredger will maintain adequate clearance between vessels and the seabed at all states of the tide and reduce operations speed to ensure that excessive turbidity is not generated by turbulence from vessel movement or propeller wash.	Marine Dredging/ During construction	Contractor(s)		✓		-

EIA Reference	Recommended Environmental Protection Measures/ Mitigation Measures	Objectives of the recommended measures & main concerns to address	Implementation Agent	Implementation Stage			Relevant Legislation & Guidelines
				D	C	O	
S6.9	The contractor shall regularly inspect the silt curtains and check that they are moored and marked to avoid danger to marine traffic. Regular inspection on the integrity of the silt curtain should be carried out by the contractor and any damage to the silt curtain shall be repaired by the contractor promptly. Relevant marine works shall be stopped until the repair is fixed to the satisfaction of the engineer.	Marine Dredging/ During construction	Contractor(s)		✓		-
S6.9	All vessels should be well maintained and inspected before use to limit any potential discharges to the marine environment.	Marine Dredging/ During construction	Contractor(s)		✓		-
S6.9	All vessels must have a clean ballast system.	Marine Dredging/ During construction	Contractor(s)		✓		-
S6.9	No discharge of sewage/grey wastewater should be allowed. Wastewater from potentially contaminated area on working vessels should be minimized and collected. These kinds of wastewater should be brought back to port and discharged at appropriate collection and treatment system.	Marine Dredging/ During construction	Contractor(s)		✓		-
S6.9	No soil waste is allowed to be disposed overboard.	Marine Dredging/ During construction	Contractor(s)		✓		-
S6.9	Silt removal facilities such as silt traps or sedimentation facilities will be provided to remove silt particles from runoff to meet the requirements of the TM standard under the WPCO. The design of silt removal facilities will be based on the guidelines provided in ProPECC PN 1/94. All drainage facilities and erosion and sediment control structures will be inspected on a regular basis and maintained to confirm proper and efficient operation at all times and particularly during rainstorms. Deposited silt and grit will be removed regularly.	Land site & drainage/ During construction	Contractor(s)		✓		ProPECC PN 1/94 TM Standard under the WPCO

Appendix B

Tentative Programme for Marine-based Works

Dredging at Intake & Outfall

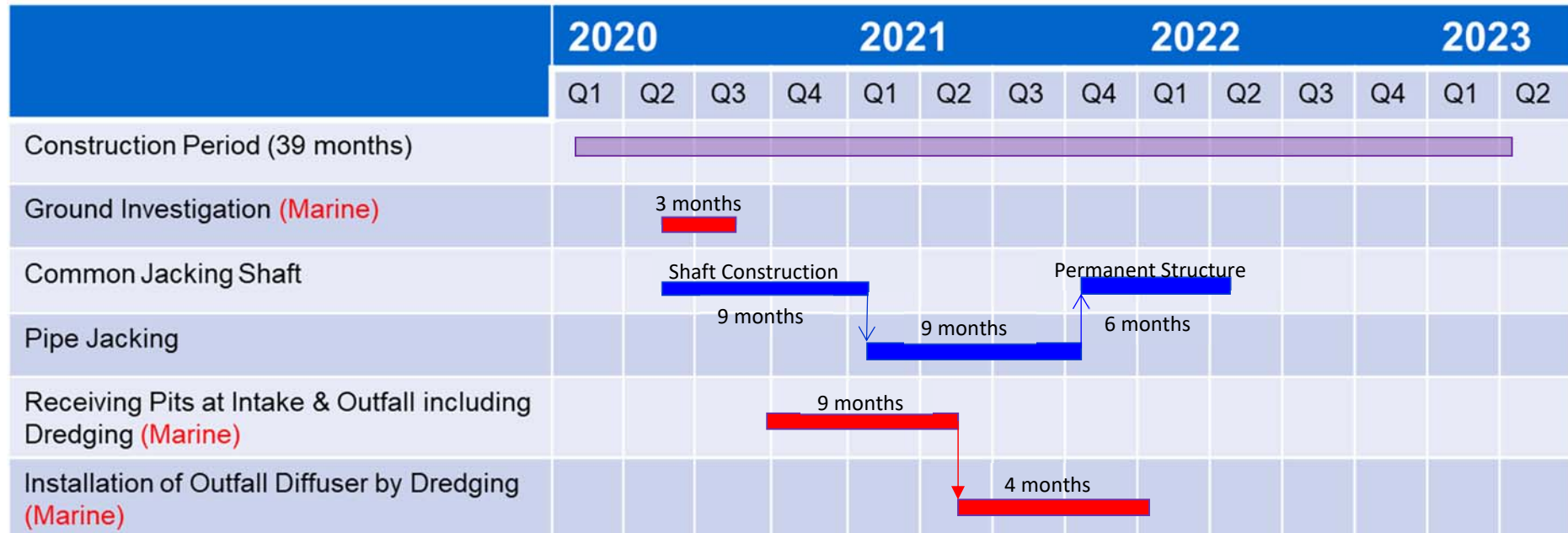

Appendix C

Specifications of Geotextile for Silt Curtain



GEONIA®

Silt Protector

We develop geosynthetics, under the mission of protecting environment as well as human, and supplying highly efficient and cost-effective solutions to global clients.



HEAD OFFICE (SEOUL) W 1707 Dangsan SK V1 Center, 11, Dangsan-ro 41-gil, Yeongdeungpo-gu, Seoul 150-806, Rep. of KOREA
Tel: +82-2-539-9700 Fax: +82-2-539-9710 E-mail: overseas@egeonia.com

R&D CENTER (GIMCHEON) 55-2, Dogok-ri, Jirye-myeon, Gimcheon-si, Gyeongsangbuk-do, 740-932, Rep. of KOREA
Tel: +82-2-539-9700 Fax: +82-2-539-9710

FACTORY 1 (GIMCHEON) 55-2, Dogok-ri, Jirye-myeon, Gimcheon-si, Gyeongsangbuk-do, 740-932, Rep. of KOREA
Tel: +82-54-436-0800 Fax: +82-54-436-0550

FACTORY 2 (GIMCHEON) 123, Apogongdan-gil, Apo-eup, Gimcheon-si, Gyeongsangbuk-do, 740-862, Rep. of KOREA
Tel: +82-54-436-0800 Fax: +82-54-436-0550

VIETNAM SALES OFFICE (HOCHIMINH) 41 le trung Nghia P12 Tan Binh district Hochiminh Vietnam
Tel: +84-8-3811-2772 Fax: +84-8-3948-1920 E-mail: day0323@naver.com

JAPAN SALES OFFICE (TOKYO) Nakagawa BLDG, 4FL 1-14-8, Nishishinbashi, Minato-ku, Tokyo, JAPAN 105-0003
Tel: +81-3-3507-9595 Fax: +81-3-5532-8624



SILT PROTECTOR

PRODUCT

GEONIA® Silt Protector

GEONIA® Silt Protector is a silt fence installed in water for preventing spread of environmental contaminants induced by coastal and riverside construction.

Leakage of silt from marine and sewage constructions has a serious influence on marine resources and natural environment of surrounding regions.

GEONIA® Silt Protector is used to preserve the natural environment and protect marine resources. By blocking a specific water zone with a special membrane composed of high strength synthetic fiber, soil particles that occur in the area are filtered and precipitated to prevent leakage and spread of silt water.

Application

- Protection of sea farming and swimming beach from nearby coastal construction
- Reclamation Protection
- Protection of revetment contamination
- Revetment of contaminant

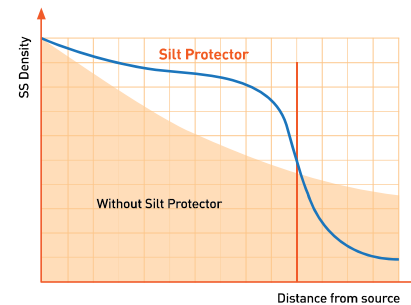
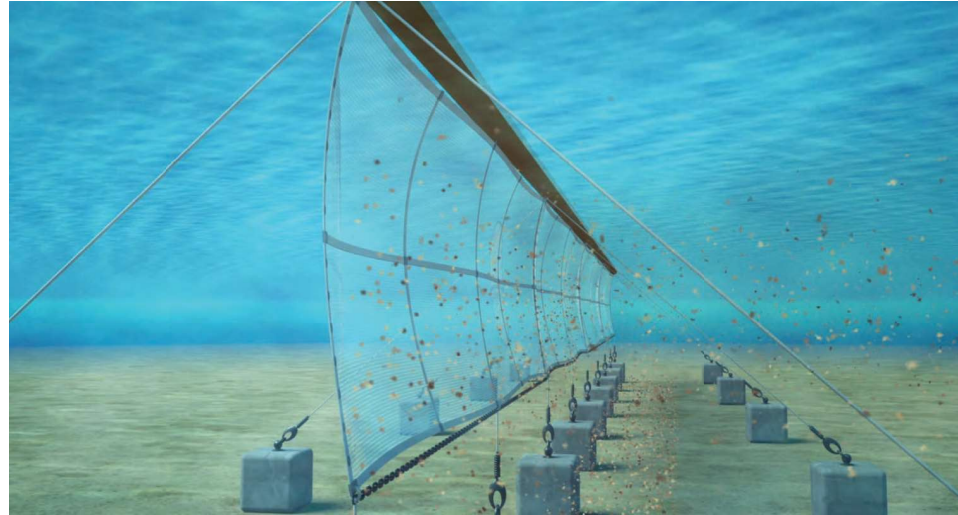

Function

The main function of the GEONIA® Silt Protector is to enclose turbidity and to minimize the influences on outside sensitive areas. Enclosed by Silt Protector, current velocity inside is much lower than outside velocity. This means the GEONIA® Silt Protector is accelerating sedimentation of silt by reducing the flow of velocity.

- The acceleration of the settlement of silt by interference of particles – The installation of GEONIA® Silt Protector suppresses the diffusion of the pollution and make the soil particles interfere with each other to accelerate their settlement.
- The reduction of distance required to settle the silt – As shown, the installation of GEONIA® Silt Protectors narrows the settlement range, resulting in minimizing the diffusion of pollution after the unit.

Without GEONIA® Silt Protector

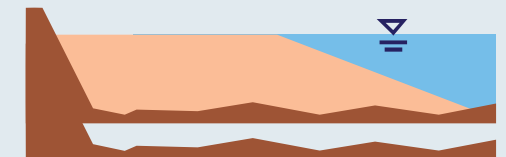

With GEONIA® Silt Protector

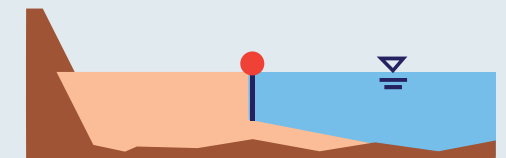

GEONIA® SILT PROTECTOR

TYPES

Tube Type

High external force of tide, wave and wind.

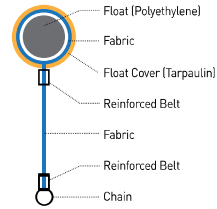
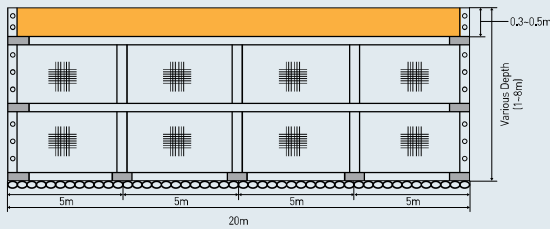

Durable Tube Type

High external force of tide, wave and wind + long resistance from the sunlight



A broken PVC coated fabric in a part of the float

A durable fabric for the float using high tenacity colored yarn

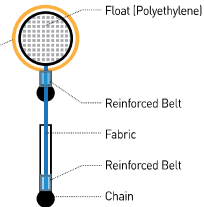

Durable Tube Type GEONIA® Silt Protector applies a durable fabric for the float device by using high tenacity colored yarn, which was improved to solve the problem of fault construction, poor visibility caused by a damaged PVC coated fabric, and marine pollution of a broken PVC coated fabric.

Covering Head Type

Less external force than tube type / easy to install

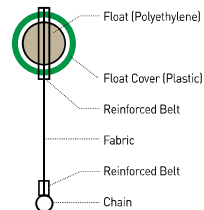
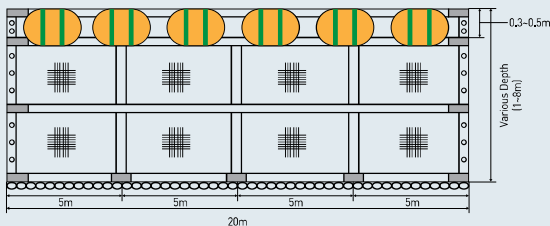

INSTALLATION

Installation of Tube Type GEONIA® Silt Protector

Assembly

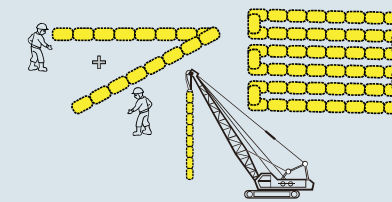

■ Connect each unit of Silt Protectors (Assemble on land)



Production of Anchors

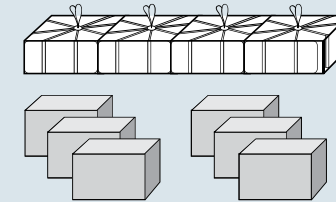

■ Make Ton Bag Anchors or Concrete Blocks



Transportation

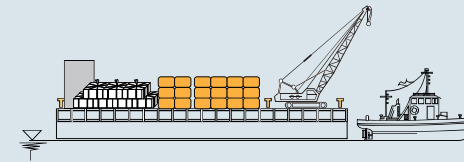

■ Load on to barge and move to where you want to install



Installation

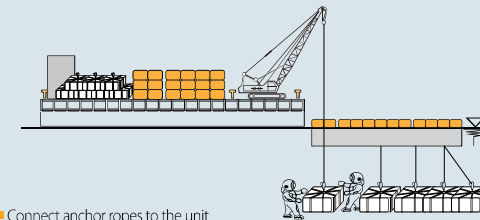

■ Connect anchor ropes to the unit



GEONIA® Silt Protector DSP Technical Data Sheet
 High Performance Silt Protector (Floating Curtain)

www.egeonia.com
DSP15 (150/150)

Mechanical Properties	Test Method		Unit		Value
Physical Properties					
Tensile Strength	MD	ASTM D4595	kN/m	≥	150
Tensile Strength	CD	ASTM D4595	kN/m	≥	150
Elongation	MD	ASTM D4595	%	≤	15
Elongation	CD	ASTM D4595	%	≤	15
Rate of Contraction		ISO 7771	%	±	0.2
Hydraulic Properties					
Water flow rate (h:50mm)		ASTM D4491	l/m ² /sec (mm/sec)	≥	1.0
Water Permittivity (h:50mm)		ASTM D4491	sec ⁻¹	≥	0.02
Apparent Opening Size(O ₉₅)		ASTM D4751	mm	≤	0.075

Above data sheet is our standard properties for the reference usage. DAEYOUN GEOTECH will not be responsible caused by any discrepancy with above data sheet. Please contact us if you need specified data sheet.

GEONIA® is a registered trademark of DAEYOUN GEOTECH.
MADE IN KOREA



DSP METALIC PARTS METARIAL AND COATING

2014-12-24

ITEM	METARIAL	COATING
EYELET	STEEL (S20C)	PAINTING (oil based paint)
STEEL PLATE	STEEL (S20C)	GALVANIZED (50~80μm)
REINFORCED STEEL PLATE	STEEL (S20C)	HOT DIP GALVANIZE (over 80μm)
BOLT&NUT	STEEL (S20C)	GALVANIZED (50~80μm)
CHAIN	STEEL (S20C)	COAL TAR PAINTING

* Above materials and coating methods can be changed according to manufacturer's decision.

* Any kind of change will be noticed to buyer in advance when it occurred.

Installation Guide (Connecting curtain and curtain)

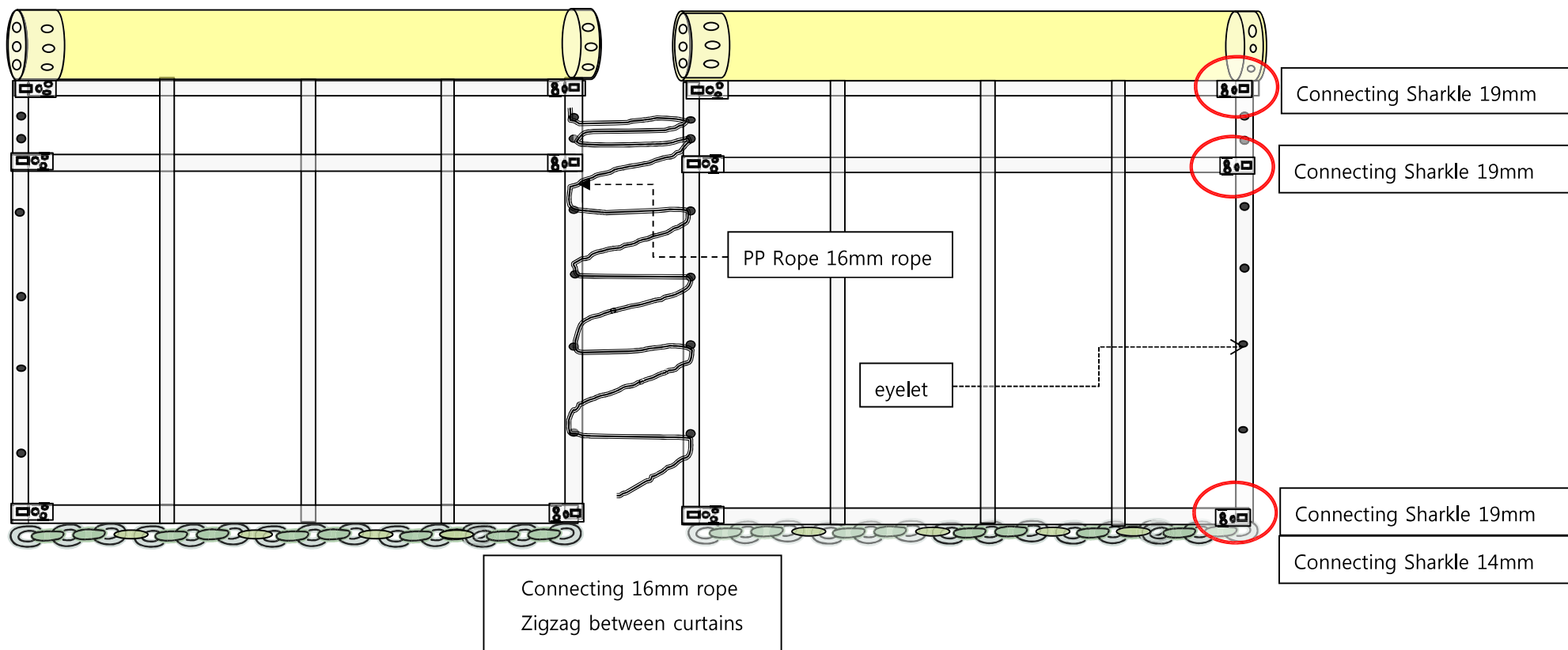

* Number of connections (between curtain and curtain)

	19mm sharkle	No. of eyelet
2m height of curtain	3	6
3m height of curtain	4	9
4m height of curtain	4	12
5m height of curtain	5	15
6m height of curtain	5	18

Installation Guide (Temporary tying curtains)

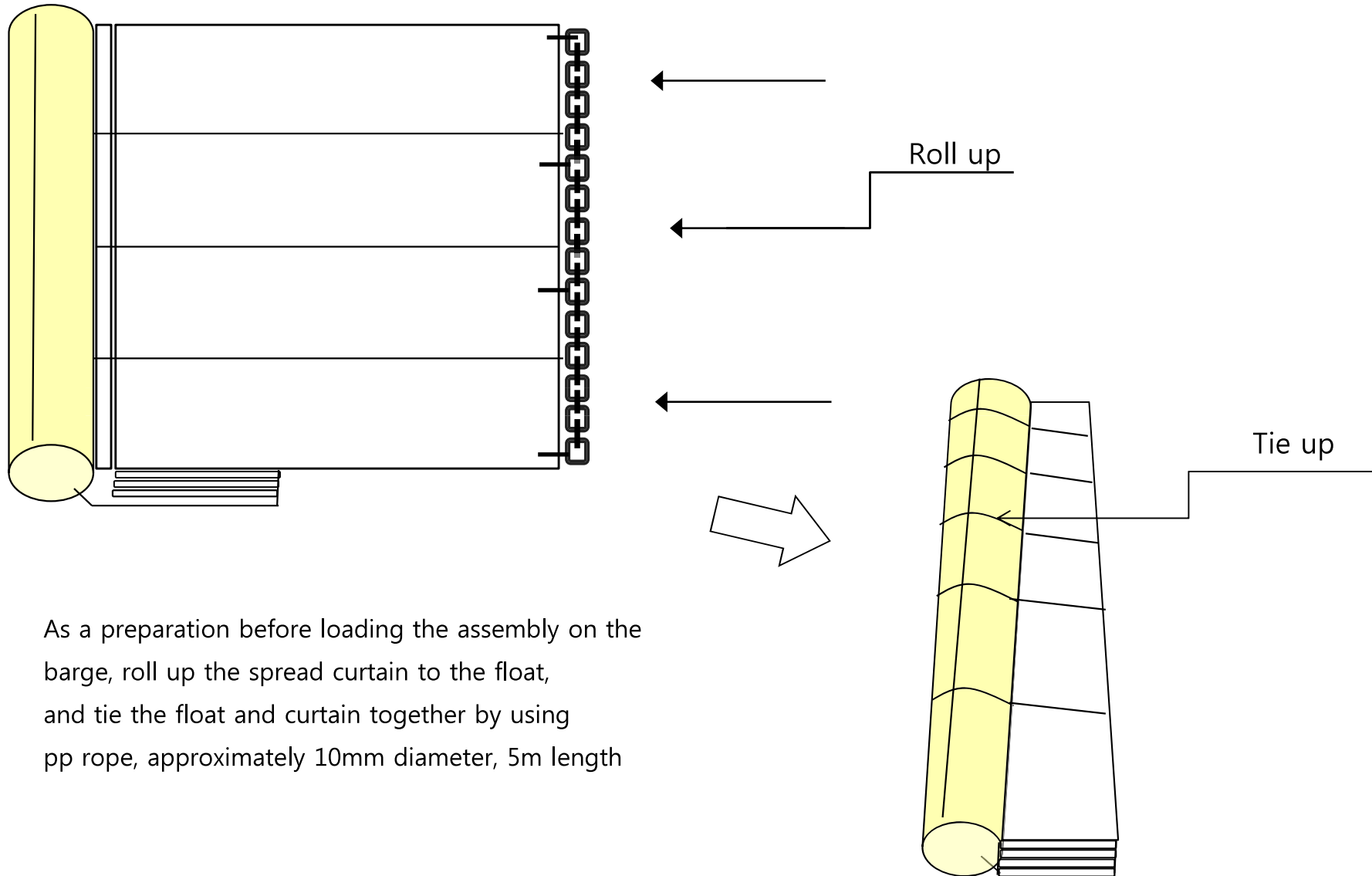

As a preparation before loading the assembly on the barge, roll up the spread curtain to the float, and tie the float and curtain together by using pp rope, approximately 10mm diameter, 5m length

Caution

Caution

Designate a person who is in charge of management of the Silt Protector.

If an environment that exceeds the design conditions is estimated, remove the Silt Protector immediately, or the unit may be damaged.

If the Silt Protector requires a repair, take necessary actions soon. If it is left without being repaired, the function of the unit may be affected adversely or the damage may expand so that it cannot be repaired.

If the Silt Protector has been dislocated from the proper position or the layout has been deformed, restore it to original position or formation immediately. Otherwise, serious accident may be caused.

Be careful not to damage the float and curtain when removing sea shells and plants from these components.

The float is made of Styrofoam which is inflammable. Keep fire away from this component.

Preconditions for maintenance

Check the Silt Protector periodically, and any component that have been deteriorated due to aging must be repaired or replaced with new component.

Parts

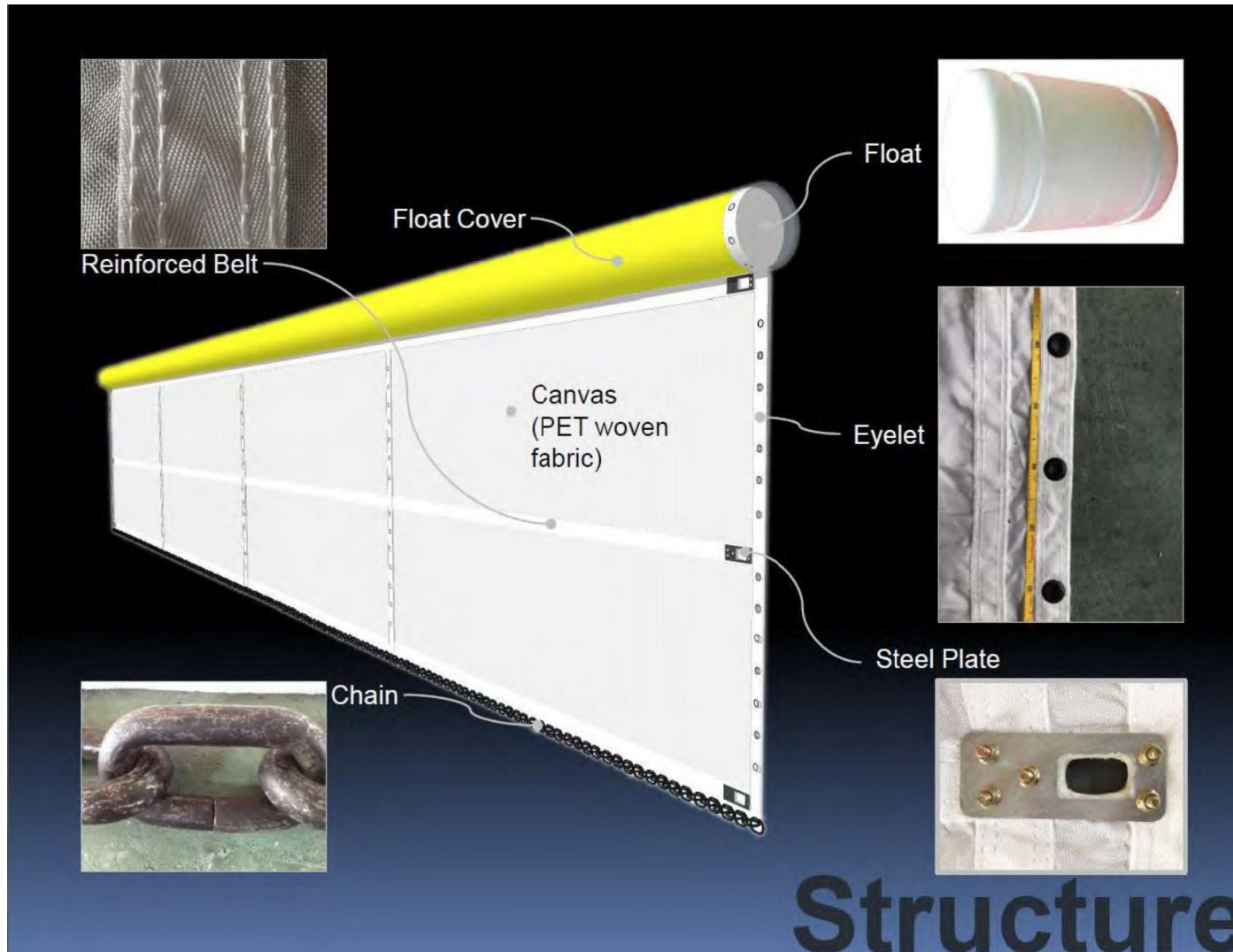

Appendix D

Typical Sections of Proposed Floating Type Silt Curtain

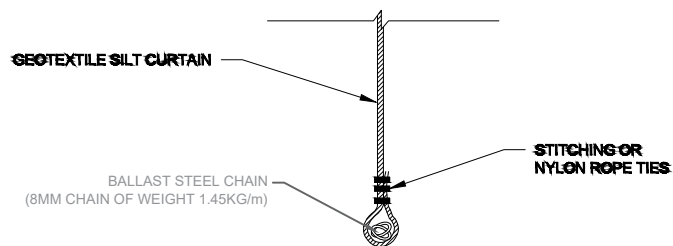
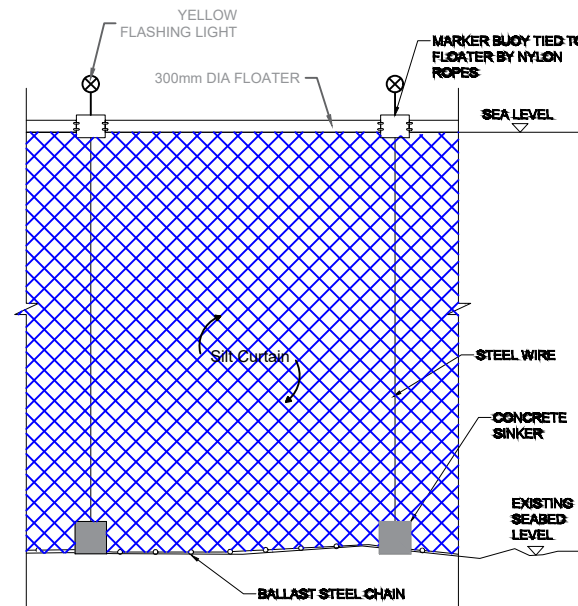
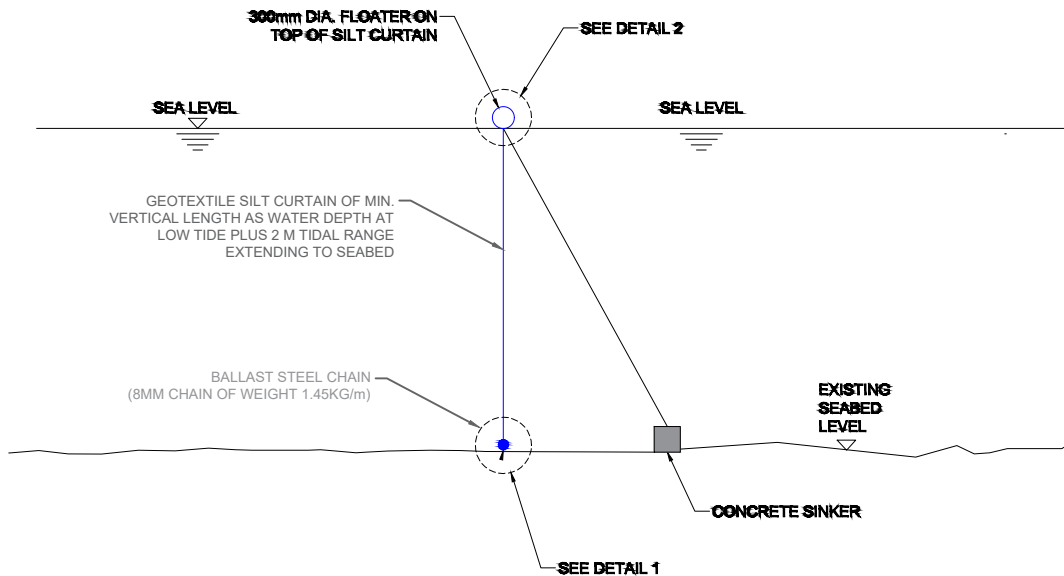

DETAIL 1 (BALLAST STEEL CHAIN)

N.T.S.

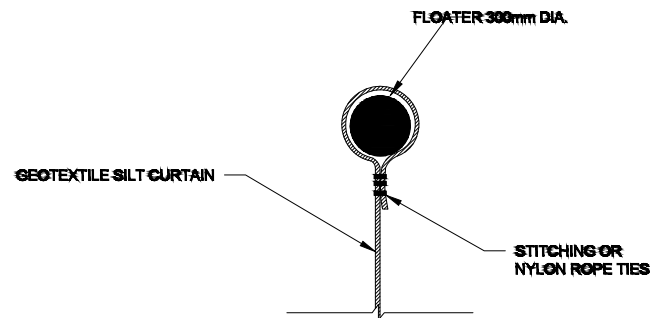

DETAIL 2 (FLOATER)

N.T.S.

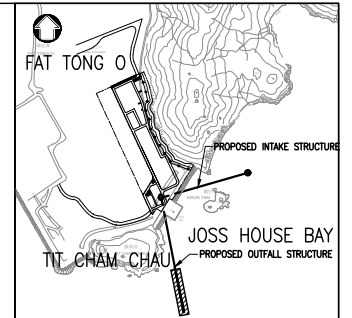

SETTING OUT POINT OF GAZETTED POTENTIAL DREDGING ZONE

POINT	EASTING	NORTHING
E	846661.15	813776.52
F	846708.52	813582.21
G	846786.25	813601.16
H	846726.67	813795.47

Rev	Description	By	Date
Employer			
Employer's Consultant			
Tenderer			
Designer			
Project title CONTRACT NO. 13/WSD/17 DESIGN, BUILD AND OPERATE FIRST STAGE OF TSEUNG KWAN O DESALINATION PLANT			
Drawing title The Typical Section of Floating type Silt Curtain			
Drawing no.	-		Rev. 0
Drawn CAD	Date	Checked	Approved
Scale	AS SHOWN (A3)	Status	-

Appendix E

Typical Sections of Proposed Cage (Framed) Type Silt Curtain

DESIGN A

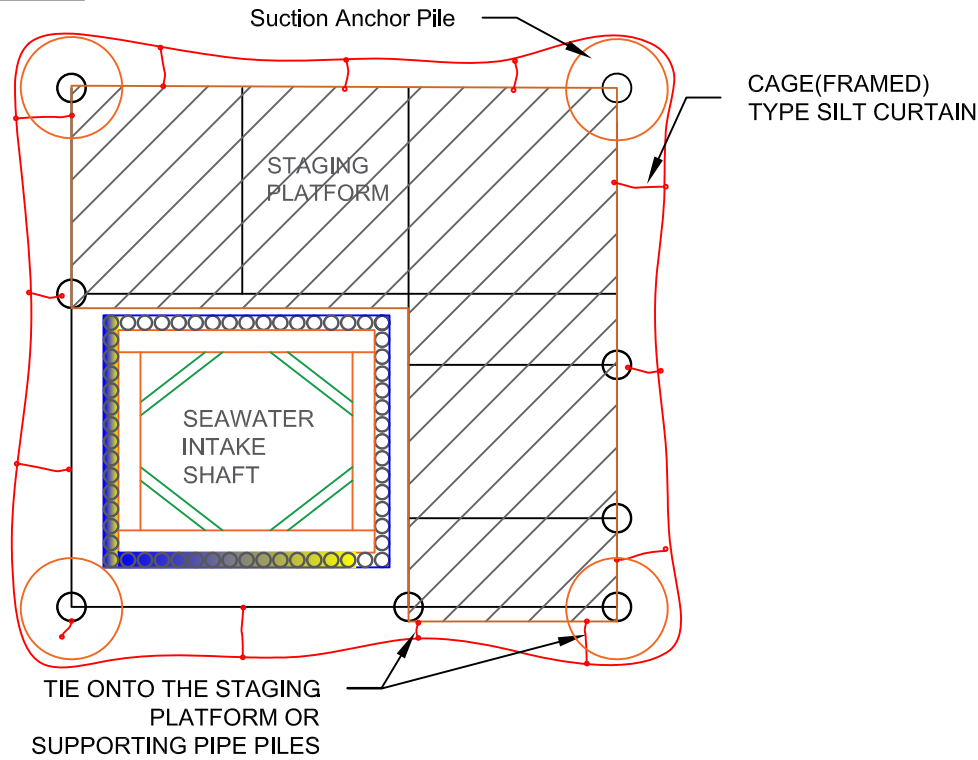

DESIGN B

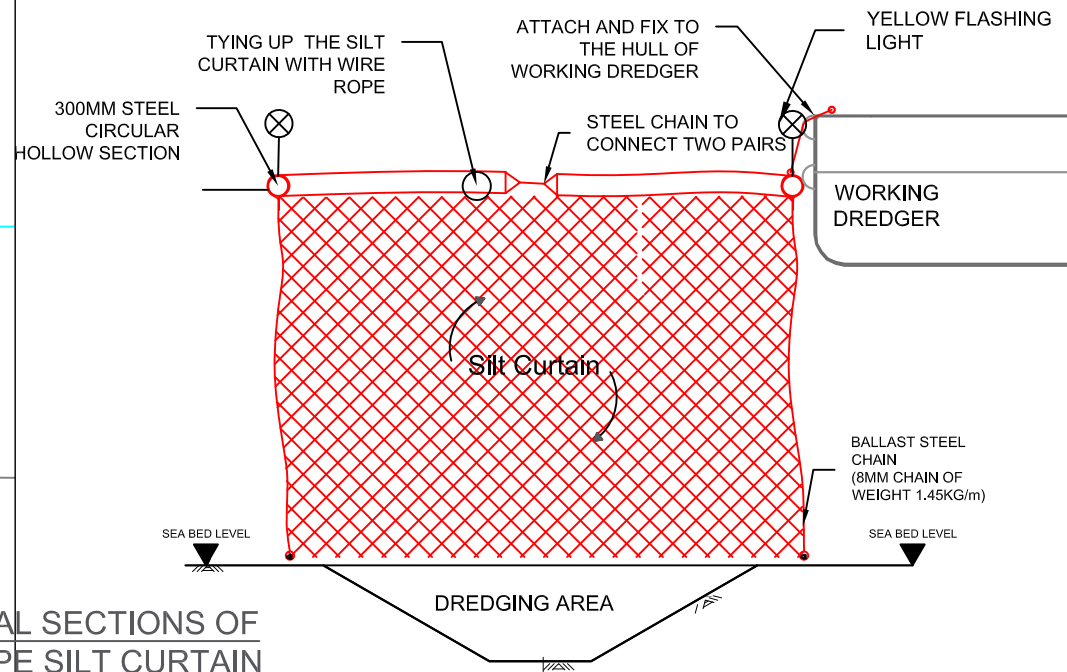
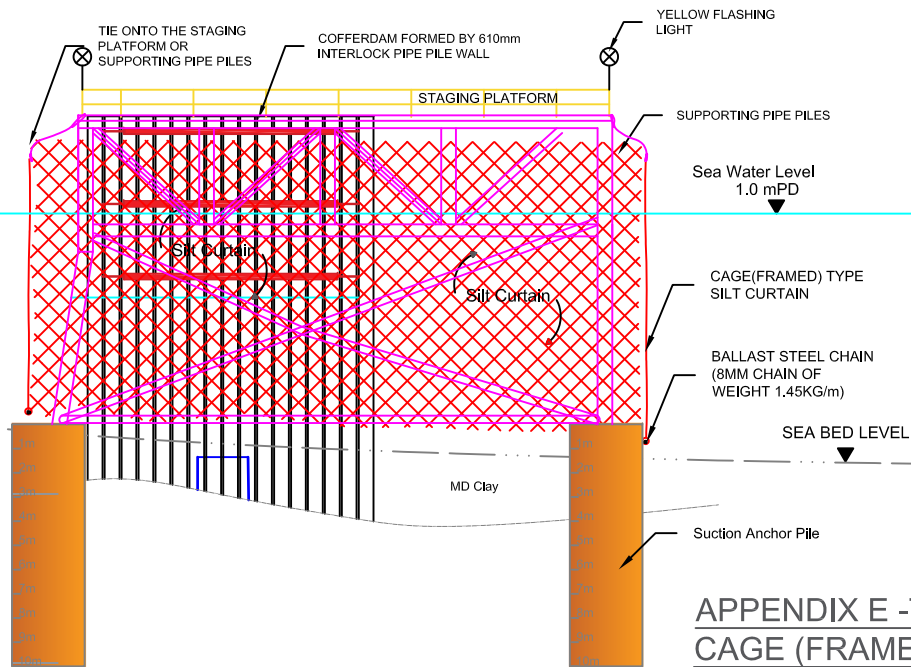
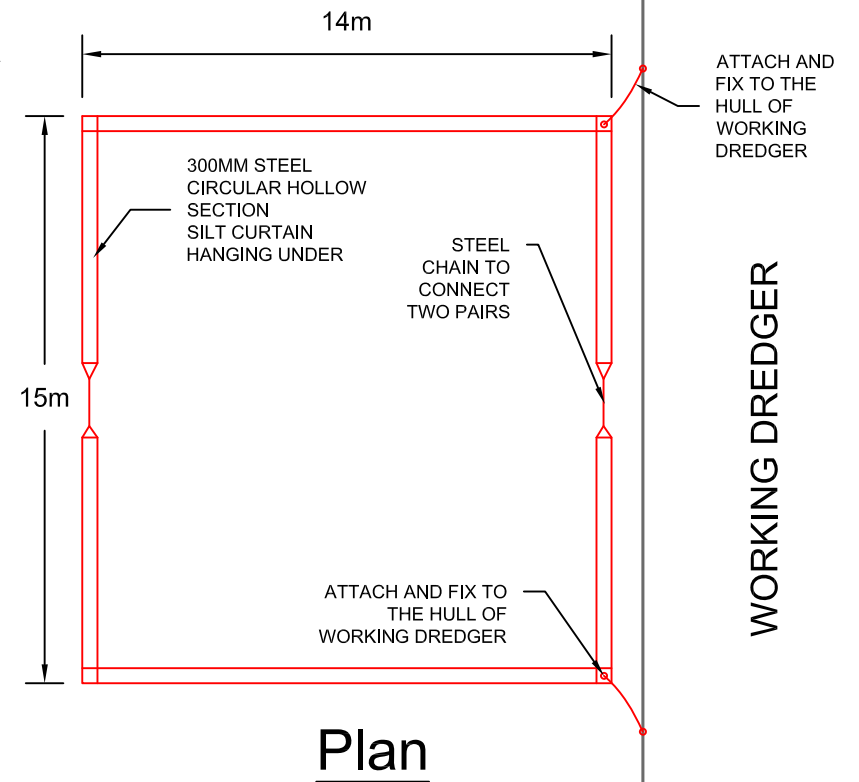

APPENDIX E - TYPICAL SECTIONS OF CAGE (FRAMED) TYPE SILT CURTAIN

Appendix F

Layout of Deployment of Combined Use of Floating Type and Cage (Framed) Type Silt Curtains at Receiving Pit of Seawater Intake

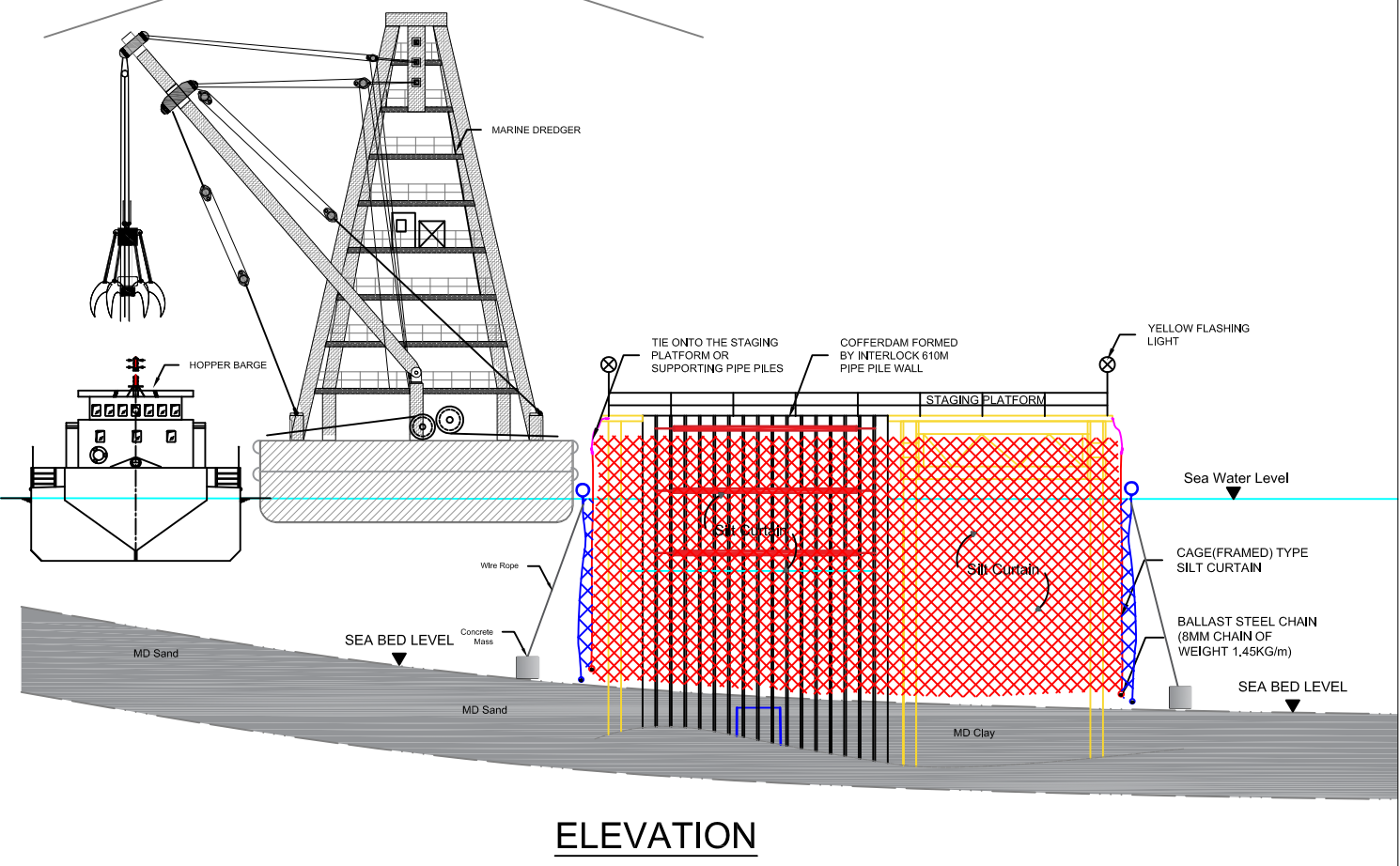
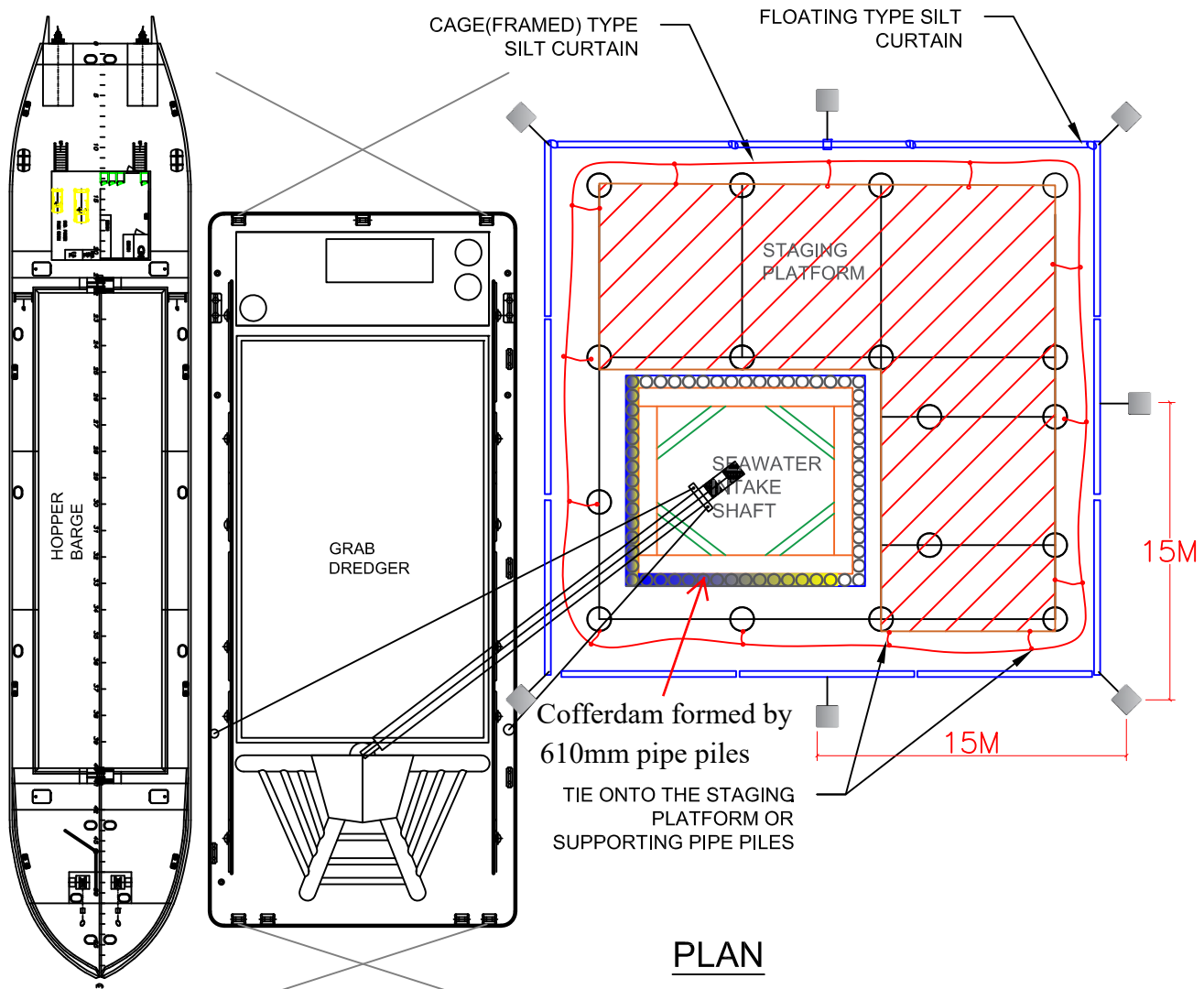

APPENDIX F - LAYOUT OF DEPLOYMENT OF COMBINED USE OF FLOATING TYPE AND CAGE (FRAMED) TYPE SILT CURTAINS AT RECEIVING PIT OF SEAWATER INTAKE

Appendix G

Layout of Deployment of Floating Type Silt Curtain Deployment at Receiving Pit of Marine Outfall

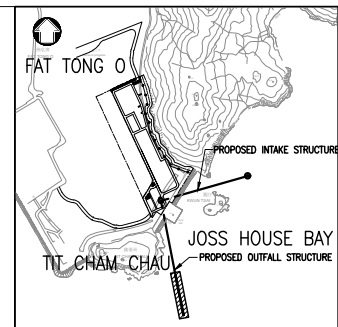

LOCATION PLAN

Rev	Description	By	Date
	Employer		
	Employer's Consultant		
	Tenderer		
	Designer		
Project title CONTRACT NO. 13/WSD/17 DESIGN, BUILD AND OPERATE FIRST STAGE OF TSEUNG KWAN O DESALINATION PLANT			
Drawing title Marie Outfall Receiving Pit Floating Type Silt Curtain layout			
Drawing no.	-	Rev.	0
Drawn CAD	Date	Checked	Approved
Scale AS SHOWN (A3)	Status	-	-

© COPYRIGHT RESERVED

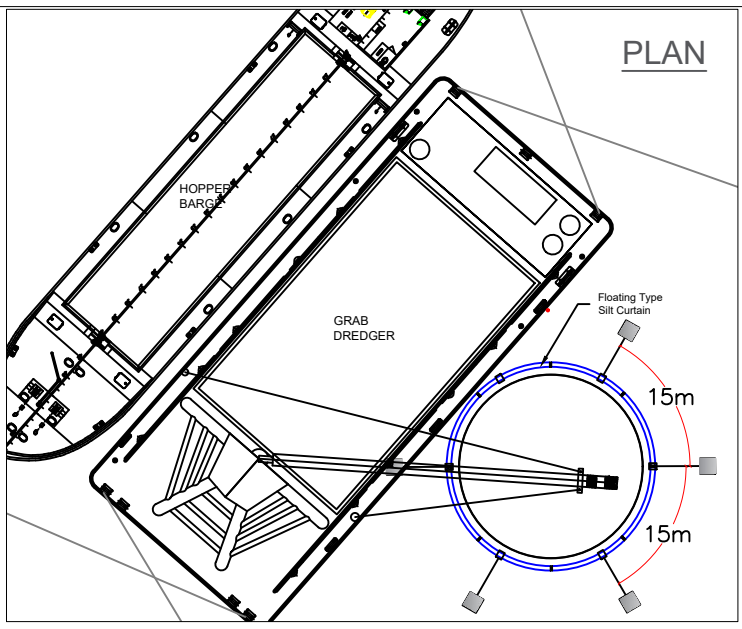

PLAN

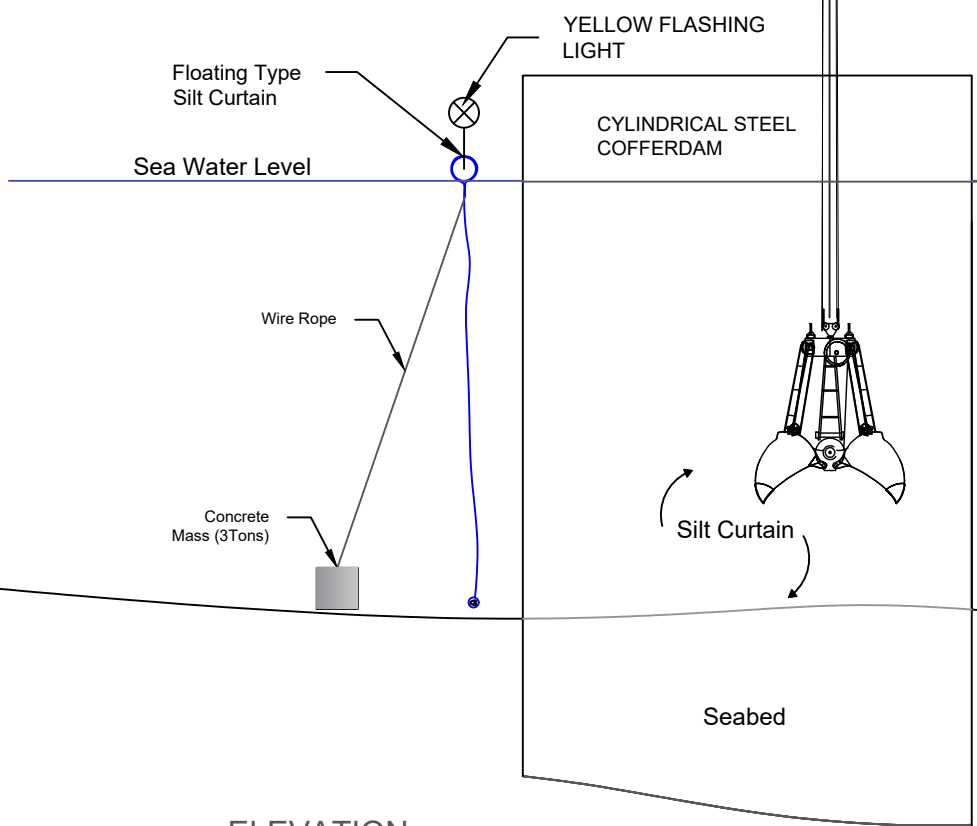
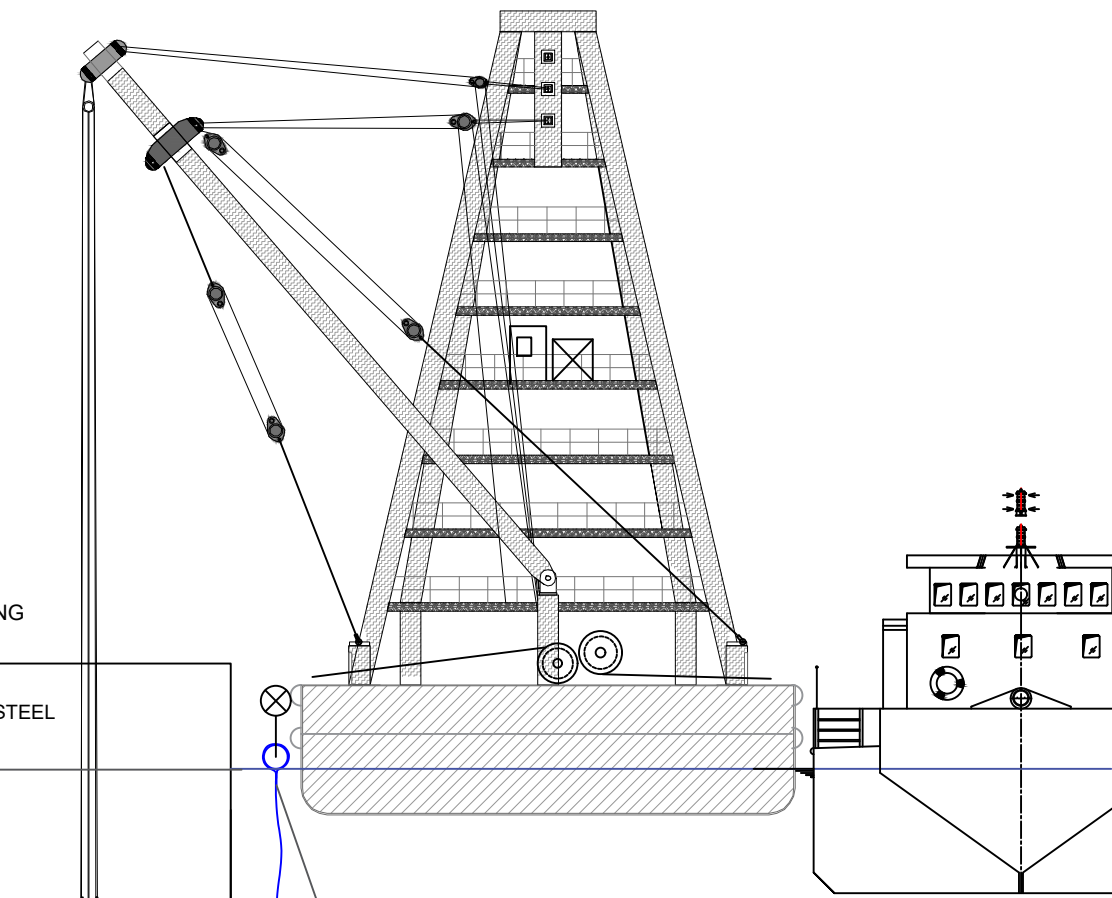

ELEVATION

APPENDIX G - LAYOUT OF DEPLOYMENT OF FLOATING TYPE SILT CURTAIN AT RECEIVING PIT OF MARINE OUTFALL

Appendix H

Layout of Deployment of Cage (Framed) Type Silt Curtain Deployment at Submarine Outfall Diffuser

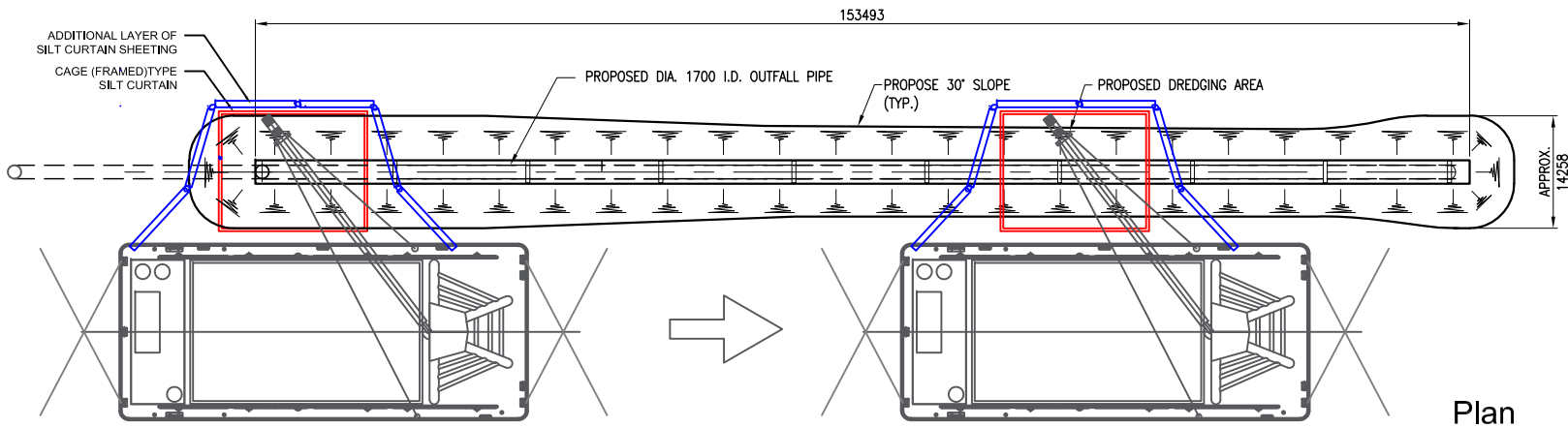

Plan

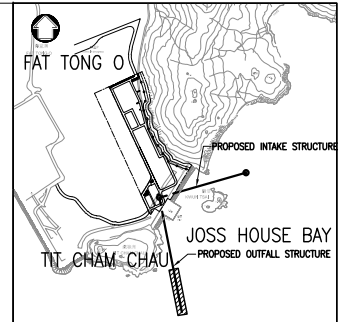

LOCATION PLAN

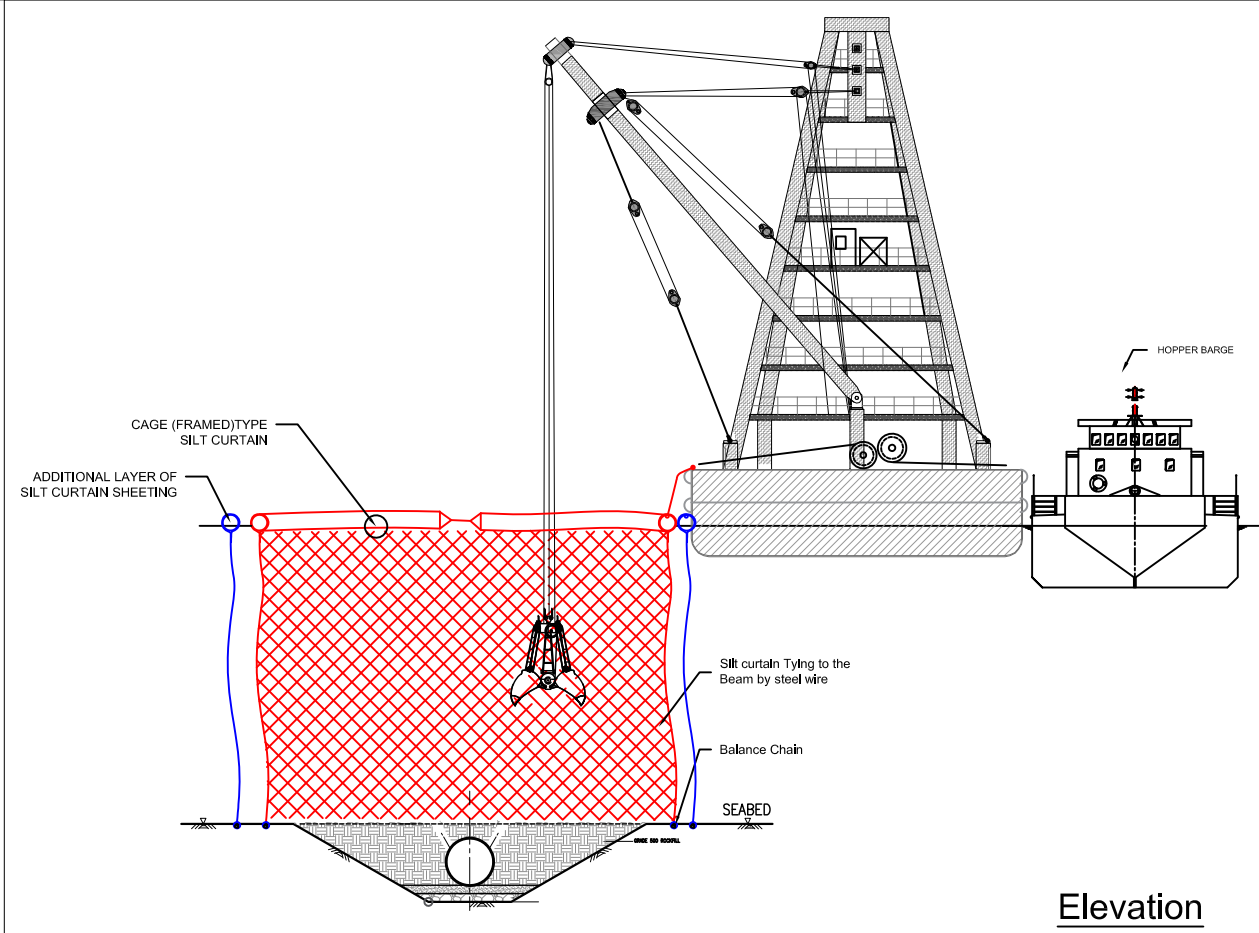

Elevation

Rev	Description	By	Date
Employer			
Employer's Consultant			
Tenderer			
Designer			
Project title CONTRACT NO. 13/WSD/17 DESIGN, BUILD AND OPERATE FIRST STAGE OF TSEUNG KWAN O DESALINATION PLANT			
Drawing title Submarine Outfall Diffuser Silt curtain Layout Plan			
Drawing no. -			Rev. 1
Drawn CAD	Date	Checked	Approved
Scale AS SHOWN (A3)	Status -		

APPENDIX H- LAYOUT OF DEPLOYMENT OF DOUBLE LAYER SILT CURTAIN AT SUBMARINE OUTFALL DIFFUSER

Appendix I

Silt Curtain Inspection Checklist

Employer : Water Supply Department
 Supervising Officer : Black & Veatch (B&V)
 Main Contractor : AJC Joint Venture

Silt Curtain Daily Inspection Checklist

Location: Intake Receiving Pit/ Outfall Receiving Pit/ Outfall Diffuser

Inspection Date and Time: _____

Item	Description	Condition		Immediate Action Required?		Target Rectification Date	Remarks
		Yes	No	Yes	No		
1	Any floating debris/ refuse within silt screen/ curtain? 隔泥幕內沒有任何垃圾?						
2	Tying to the frame / bouys in good condition? 浮泡情況良好?						
3	The condition of the tying ropes? 繫上的繩索情況良好?						
4	Curtain intact and in good condition? 隔泥幕完整無缺?						
5	No any obstruction to water flow between curtain? 隔泥幕之間沒有任何阻礙海水流動?						

*Please Tick the Appropriate Box

Checked By: _____

On Behalf of AJC Joint Venture

Endorsed By: _____

On Behalf of B&V

Appendix J

Project-Specific Implementation Schedule of the SCDP

Recommended Mitigation Measures (What Measures)	Objective of the Measures (Why)	Who to Implement / Maintain the Measures? (Who)	Location of the Measures (Where)	When to Implement the Measures? (When)	Reference in this SCDP
<p>Deployment of silt curtain shall be carefully planned and implemented</p> <p>a. To deploy the silt curtain in accordance with the SCDP</p> <p>b. The minimum lap length of contiguous silt curtain section is 1 m, and the minimum width of gap between first and second layer of silt curtain is 1 m</p> <p>c. Localized silt curtain either of floating or framed type is deployed when placing fills onto the seabed</p> <p>d. Updated silt curtain layout, where necessary shall be reviewed and agreed by the ET and IEC</p>	<p>To carefully plan and deploy silt curtain to contain and minimize environmental impact of concerned marine works.</p>	<p>The Contractor / ET/ IEC</p>	<p>See Silt Curtain Layout plan(s) in Appendices F, G & H of the SCDP</p>	<p>Throughout the construction phase when the concerned marine works are taking place</p>	<p>Refers to Sections 3 & 4 of the SCDP</p>
<p>Operation and Maintenance of Silt Curtain</p> <p>a. Before operation of silt curtain, a Silt Curtain Daily Inspection (SCDI) Checklist was prepared for agreement by the ET and IEC. The specific location of the site curtains deployed, inspection date & time and the conditions of such silt curtain (e.g. whether the supporting frame/buoys, tying rope and geotextile surface are properly functioned and any regular collection of floating debris around the silt curtain) shall be provided in the Checklist for auditing</p> <p>b. Before commencement of works every day, the condition of all silt curtains shall be checked and signed by the on-board supervisor(s) following the SCDI Checklist, with the signed Checklist kept on site and copied for ET's and IEC's record.</p>	<p>To operate and maintain the silt curtain(s) properly to minimize environmental impacts of marine works</p>	<p>The Contractor / SOR/ ET / IEC</p>	<p>See Silt Curtain Layout plan(s) Appendices F, G & H of the SCDP</p>	<p>Throughout the construction phase when marine works are taking place</p>	<p>Refers to Appendix I & Section 6 of the SCDP</p>

Recommended Mitigation Measures (What Measures)	Objective of the Measures (Why)	Who to Implement / Maintain the Measures? (Who)	Location of the Measures (Where)	When to Implement the Measures? (When)	Reference in this SCDP
<p>The Checklist shall conclude any need or reason for suspension of related works</p> <p>c. The silt curtain is properly anchored to bottom of seabed</p> <p>d. Diver inspection is arranged after adverse weather (i.e. Typhoon Signal No. 3 or above) and when necessary, with the confirmation on any need or reason for suspension of related works recorded on the SCDI</p> <p>e. Related works shall be suspended immediately if any damage of the silt curtain is found, until the damage is fully fixed with agreement issued by ET and IEC.</p> <p>f. Sufficient spare geotextile will be kept on site for replacement of damaged silt curtains, and the spare geotextile shall be kept in place to avoid direct contact with water and sunlight</p>					
<p>Removal of Silt Curtain</p> <p>a. Prior to removal of silt curtains, all marine works for which the silt curtains are deployed shall be stopped and visual inspection of the water quality within the area protected by silt curtains shall be conducted by the on-board supervisor(s), with photo record of sea condition copied for ET's and IEC's record, to confirm no sediment plume remaining within the works area.</p>	<p>To minimize environmental impacts due to removal of silt curtains</p>	<p>The Contractor / SOR / ET / IEC</p>	<p>See Silt Curtain Layout plan(s) Appendices F, G & H of the SCDP</p>	<p>Before removal of silt curtain</p>	<p>Refers to Section 7 of the SCDP</p>